



The new degree of comfort®



Residential Electric  
Professional *Prestige* ProTerra  
Hybrid Water Heaters

## Professional *Prestige*® ProTerra Hybrid Electric with LeakGuard™ is the most efficient water heater available

### Efficiency

- Up to 4.0 UEF reduces operating cost
- ENERGY STAR® rated

### Performance

- Delivers hot water faster than most standard electric water heaters
- Ambient operating range: 37-145° F is widest in class, offering more days of HP operation annually; designed to meet Northern Climate Spec (Tier 4)

### Easy Installation

- Easy access side connections
- Quick access to electrical junction box
- Easily replaces a standard electric water heater

### Integration

- LED Screen with built-in water sensor alert with audible alarm<sup>1</sup>
- Integrated EcoNet® WiFi-connected<sup>2</sup> technology and free mobile app gives users control over water heater, allowing for customizable temperature, vacation settings, energy savings and system monitoring at home or away. Visit Rheem.com/hybridsolutions



- Integrated leak detection and prevention system with factory installed auto water shut-off valve limits leaks to no more than 20 ounces of water<sup>1, 3</sup>
- LeakSense™ Built-in Leak Detection System detects any leak large or small, internal or external<sup>1, 4</sup>

### Operation Modes

- Energy Saver
- Heat Pump
- High Demand
- Electric
- Vacation/Away: 2-28 days (or placed on hold indefinitely)

### Plus...

- Premium grade anode rod with resistor extends the life of the tank
- 3/4" NPT water inlet and outlet; 3/4" condensate drain connections
- Incoloy stainless steel resistor elements
- Dry-fire protection
- Easy access, top mounted washable air filter
- 2" Non-CFC foam insulation
- Enhanced flow brass drain valve
- Temperature and pressure relief valve installed
- Design certified to NSF/ANSI 372 (Lead Content)

### Warranty

- 10-Year limited tank and parts warranty  
See Residential Warranty Certificate for complete information

Units meet or exceed ANSI requirements and have been tested according to D.O.E. procedures. Units meet or exceed the energy efficiency requirements of NAECA, ASHRAE standard 90, ICC Code and all state energy efficiency performance criteria.



## Professional *Prestige* ProTerra Hybrid

40, 50, 65 and 80-Gallon Capacities  
208-240 Volt / 1 PH Electric



LEED Points = 3

<sup>1</sup>Available with select models. <sup>2</sup>WiFi broadband internet connection required. <sup>3</sup>Source: Rheem Leak-Sensing Data; testing under a vacuum lock using 50-gallon tank, no expansion tank, average tank pressure of 40 psi, assuming no additional faucets are opened. <sup>4</sup>Water leaks from the heater only, as tested across scenarios including a minimum of 5.5mL/hr volume leak rate, using most common installation scenarios.

See specifications chart on next page.



INTEGRATED HOME COMFORT

# Professional *Prestige*® ProTerra Hybrid Specifications

DESCRIPTION					ENERGY INFO		FEATURES					TANK DIMENSIONS (SEE SPACE REQUIREMENTS IN DIAGRAMS BELOW)			
NOMINAL GALLON CAPACITY	RATED GALLON CAPACITY	MODEL NUMBER	MODEL VARIANT	ELECTRIC BREAKER SIZE	UNIFORM ENERGY FACTOR (UEF)	EST. YEARLY ENERGY COST	ELEMENT WATTAGE	COMPRESSOR BTU/H	SOUND LEVEL (dBA)	UEF FIRST HR. RATING G.P.H.	RECOVERY IN G.P.H 90° F RISE	HEIGHT A	DIAM. B	UNIT WT. (LBS)	APPROX. SHIP WT. (LBS.)
<b>ProTerra with LeakGuard</b>															
40	36	PROPH40 T2 RH375-SO	700646	30	3.75	\$104	4,500	4200	49	60	26	62-5/16"	20-1/4"	157	174
50	45	PROPH50 T2 RH375-SO	700643	30	3.75	\$104	4,500	4200	49	67	27	61-3/4"	22-1/4"	178	218
65	59	PROPH65 T2 RH375-SO	700644	30	3.85	\$155	4,500	4200	49	75	27	64-3/16"	24-1/4"	225	262
80	72	PROPH80 T2 RH375-SO	700645	30	4.00	\$149	4,500	4200	49	87	27	74-3/16"	24-1/4"	244	281
<b>ProTerra 30 Amp without LeakGuard</b>															
40	36	PROPH40 T2 RH375-30	700470	30	3.75	\$104	4,500	4200	49	60	27	62-5/16"	20-1/4"	157	174
50	45	PROPH50 T2 RH375-30	700467	30	3.75	\$104	4,500	4200	49	67	27	61-3/4"	22-1/4"	178	218
65	59	PROPH65 T2 RH375-30	700468	30	3.85	\$155	4,500	4200	49	75	27	64-3/16"	24-1/4"	225	262
80	72	PROPH80 T2 RH375-30	700469	30	4.00	\$149	4,500	4200	49	87	27	74-3/16"	24-1/4"	244	281
<b>ProTerra 15 Amp without LeakGuard</b>															
40	36	PROPH40 T2 RH375-15	700497	15	3.45	\$78	2,250	4200	49	46	16	62-5/16"	20-1/4"	157	174
50	45	PROPH50 T2 RH375-15	700494	15	3.75	\$104	2,250	4200	49	54	16	61-3/4"	22-1/4"	178	218
65	59	PROPH65 T2 RH375-15	700495	15	3.55	\$110	2,250	4200	49	54	16	64-3/16"	24-1/4"	225	262
80	72	PROPH80 T2 RH375-15	700496	15	3.70	\$105	2,250	4200	49	67	16	74-3/16"	24-1/4"	244	281

Estimated energy cost based on a national average electricity cost of \$0.12 /kWh. Uniform Energy Factor and rated gallon capacity based on Department of Energy (DOE) requirements. All units have integrated WiFi control board.

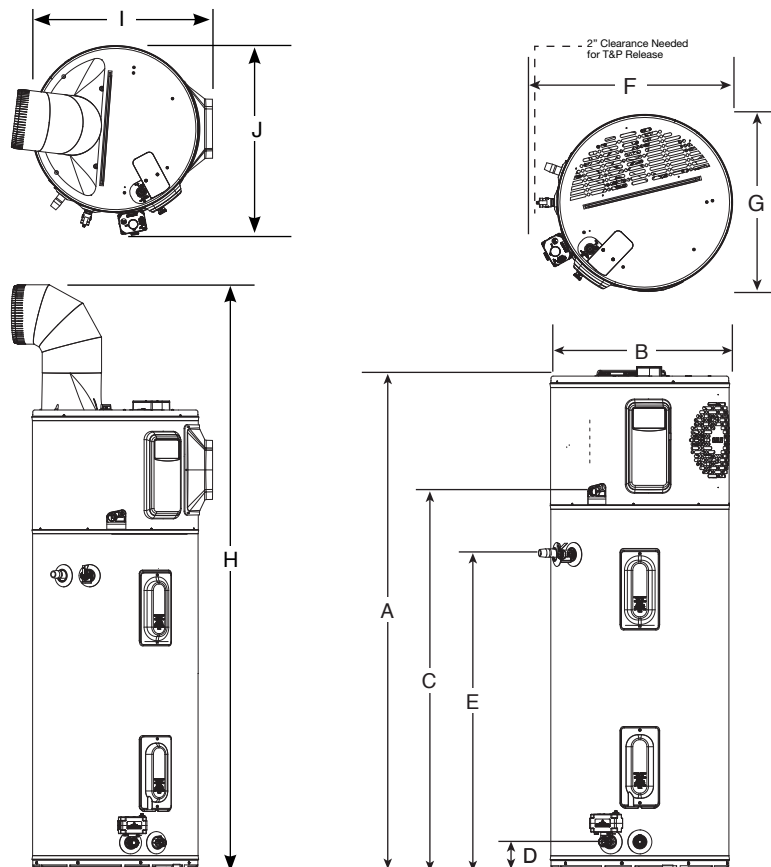

DESCRIPTION		DIMENSIONS (SHOWN IN INCHES)									
NOMINAL GALLON CAPACITY	MODEL NUMBER	A	B	C	D	E	F	G	H	I	J
40	PROPH40	62-5/16	20-1/4	47	3-5/8	39-5/8	23-3/8	20-1/2	78-7/8	22-3/8	23-1/4
50	PROPH50	61-3/4	22-1/4	47	3-5/8	39-5/8	25-3/8	22-1/2	78-5/8	24-3/8	25-9/16
65	PROPH65	64-3/16	24-1/4	49	3-7/8	42-3/8	27-1/2	24-5/8	81-1/8	26-1/2	27-3/8
80	PROPH80	74-3/16	24-1/4	59	3-7/8	52-3/8	27-1/2	24-5/8	91	26-1/2	27-3/8

# Hybrid Water Heater Installation Guidelines to Provide Optimal Efficiency

## Heater: Not Ducted

Room size: Larger than 700 ft<sup>3</sup> (e.g. 7' x 10' x 10').  
 Requirements: No additional ventilation needed.

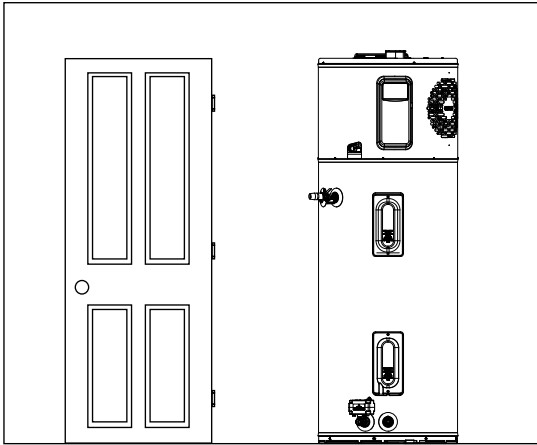

## Heater: Not Ducted

Room size: Smaller than 700 ft<sup>3</sup> (e.g. 7' x 10' x 10').  
 Requirements: Full louvered door OR two louvers top and bottom. See below.

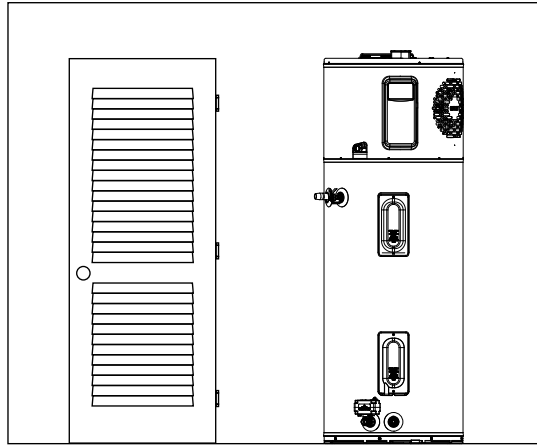

## Heater: Not ducted

Room: Small Closet

- Requirements:
- \* Air gap under door equal to 18 in<sup>2</sup> (0.75" clearance).
  - \* Louver must be located the same height on door as the air exhaust on heater.
  - \* Heater air exhaust must be positioned towards louver within one foot of door.

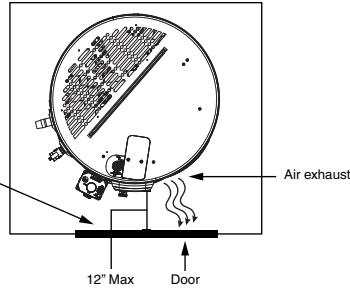
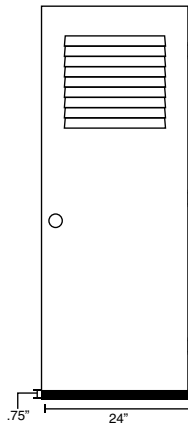

## Heater: Ducted with inlet OR outlet duct

Room size: Any size room  
 Requirements: Air gap under door equal to 18 in<sup>2</sup> (0.75" clearance)

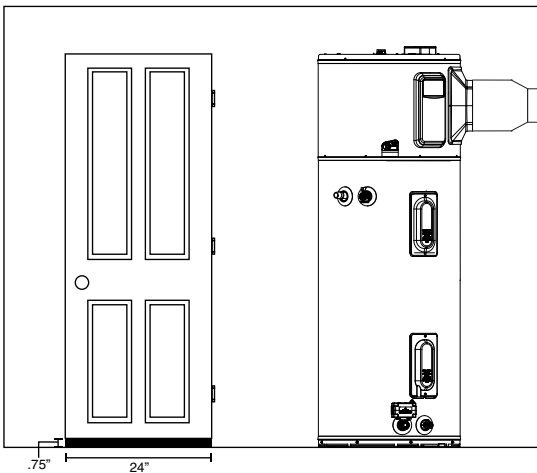

## Heater: Ducted with inlet AND outlet duct

Room size: Any size room  
 Requirements: No additional ventilation needed.

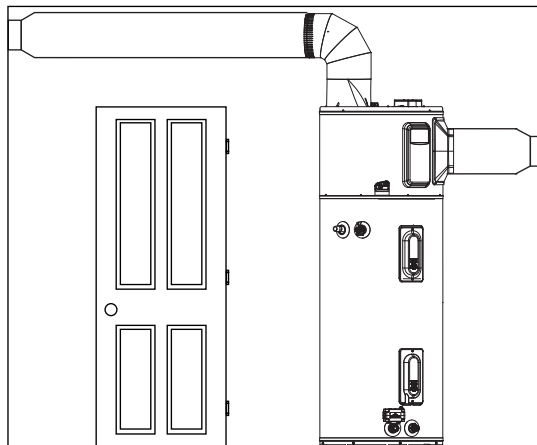



The new degree of comfort®



Residential Electric  
Professional *Prestige ProTerra*  
Hybrid Water Heaters

## Hybrid Accessories List

PART NUMBER	DESCRIPTION	USE FOR
AP19134	Leak Sensor	Automatic detection of internal and external leaks
AP20180	Shutoff Valve	Automatic shut off of water supply to unit
AP21365	Inlet Duct Adapter	Allows for ducting to be connected on the top inlet
AP17829	Outlet Duct Adapter	Allows for ducting to be connected to the unit
SP20882	Earthquake Isolation Kit	Installations in seismic regions
SP20883	Vibration Isolation Kit	Installation on non-concrete floors
SP20884	8" Diameter UL Certified Termination Kit	Termination to the outside or to the attic with 8" diameter
SP20885	7" Diameter UL Certified Termination Kit	Termination to the outside or to the attic with 7" diameter
SP20886	6" Diameter UL Certified Termination Kit	Termination to the outside or to the attic with 6" diameter
SP20887	5" Diameter UL Certified Termination Kit	Termination to the outside or to the attic with 5" diameter
SP20888	8" Rheem Approved Damper Kit	Exhaust only to the outside ducting configuration (no inlet duct)
SP20889	25' Flexible 8" Diameter Duct Kit	For up to 25' of ducting
SP20890	Rigid Elbow Duct Kit	Installation in tight places where space needs to be minimized
<b>UPGRADE KIT</b>		
SP21111	Leak Sensor & Shutoff Valve Kit	Upgrade ProTerra 15 and 30 Amp models to protect your customers home from water damage with leak detection and auto shutoff valve

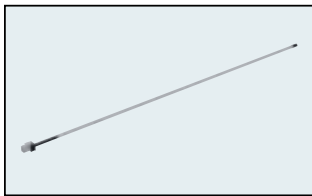

AP19134



AP20180



AP21365



AP17829



SP20882



SP20883

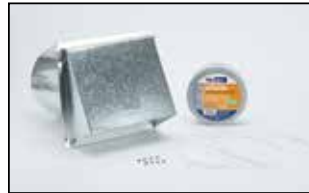

SP20884



SP20885



SP20886



SP20887



SP20888



SP20889



SP20890

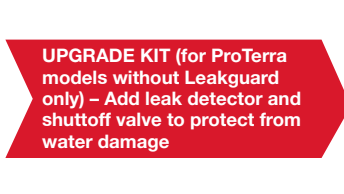

**UPGRADE KIT (for ProTerra models without Leakguard only) – Add leak detector and shutoff valve to protect from water damage**

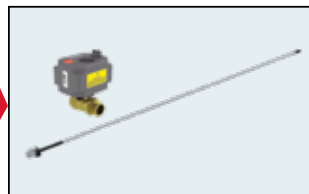

SP21111

In keeping with its policy of continuous progress and product improvement, Rheem reserves the right to make changes without notice.

Rheem Water Heating • 1115 Northmeadow Parkway, Suite 100  
Roswell, Georgia 30076 • www.rheem.com

Rheem Canada Ltd./Ltée • 125 Edgeware Road, Unit 1  
Brampton, Ontario L6Y 0P5 • www.rheem.com



INTEGRATED HOME COMFORT